

ROTARY VANE PRESSURE VACUUM PUMPS



VT16/25/40



KVT60/80



DVT100/140/160

VT/KVT/DVT series rotary vane pressure vacuum pumps is designed with reference to the same kind of advanced product. It can use vacuum suction and discharge compressed air at the same time.

Advantage: Low noise; Low temperature rise; Stable performance; Easy maintenance etc.

Application: Widely used in printing, packaging, offset machine, and other industries that need vacuum .

Application

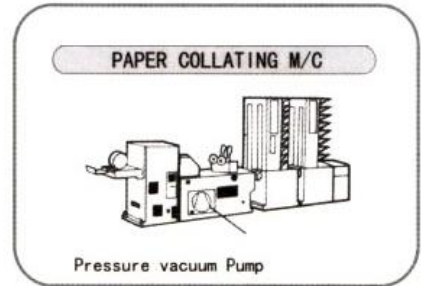
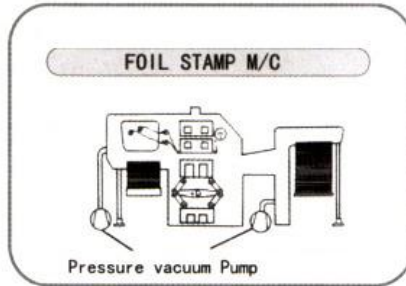
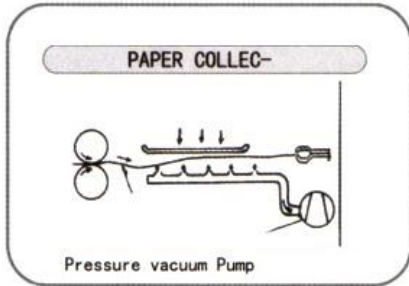
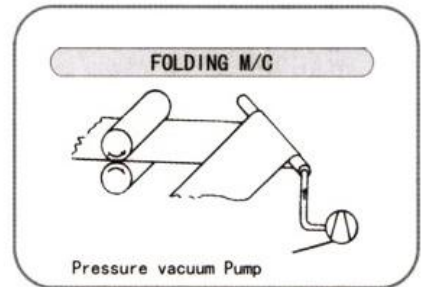
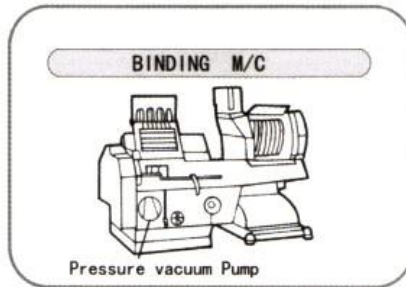
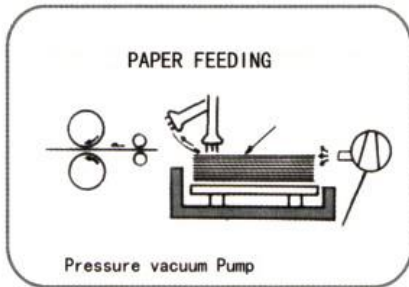

Item		VT16	VT25	VT40
Capacity m ³ /h	50HZ	16	25	40
	60HZ	20	30	48
Power KW	50HZ	0.75	1.1	1.5
	60HZ	0.9	1.5	2.2
Voltage V	50HZ	195-255/330-440	195-255/330-440	195-255/330-440
	60HZ	190-290/330-550	190-290/330-550	190-290/330-550
Motor Speed RPM	50HZ	1420	1420	1420
	60HZ	1700	1700	1700
Vacuum bar		-0.6	-0.6	-0.6
Pressure bar		+0.6	+0.6	+0.6
Noise dB(A)		69	69	68

Weight KG	36	36	45
-----------	----	----	----

Item		KVT60	KVT80	KVT100	KVT140
Capacity m ³ /h	50HZ	60	80	100	140
	60HZ	72	96	120	168
Power KW	50HZ	3	4	5.5	7.5
	60HZ	3.6	4.8	6.6	9
Voltage V	50HZ	230V/400V±10%,3PH	230V/400V±10%,3PH	220V/380V±10%,3PH	220V/380V±10%,3PH
	60HZ				
Motor Speed RPM	50HZ	1420	1420	1430	1430
	60HZ	1710	1710	1720	1720
Vacuum bar		-0.6	-0.6	-0.6	-0.6
Pressure bar		+0.6	+0.6	+0.6	+0.6
Noise dB(A)		75	75	77	78
Weight KG		74	79	129	140
Motor Type		B5/250	B5/250	B5/300	B5/300

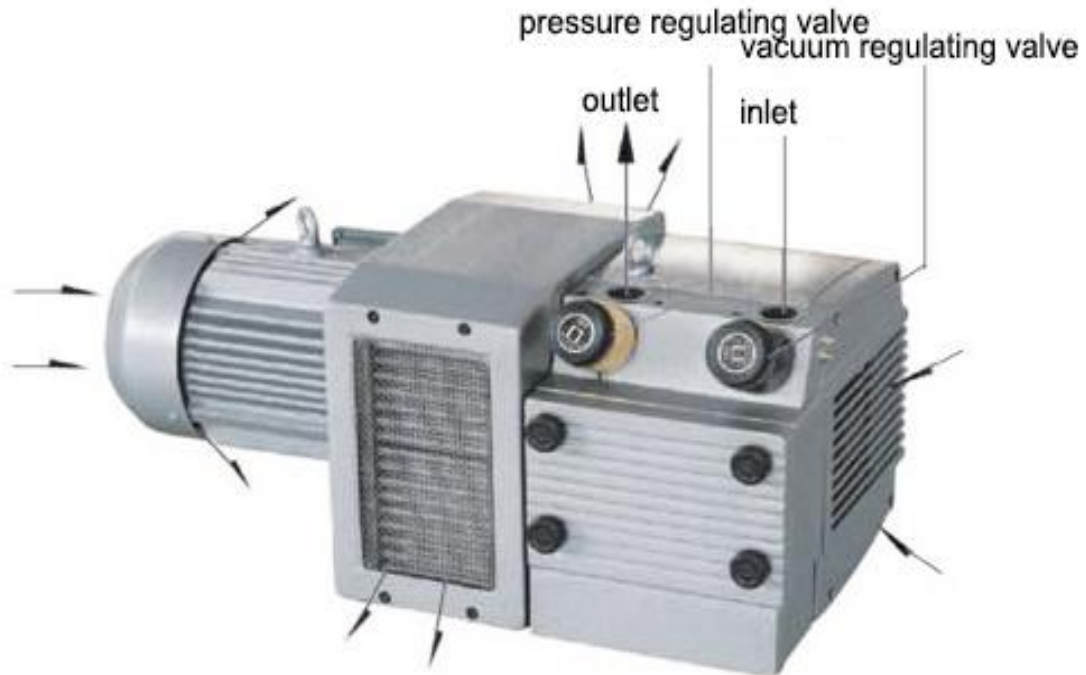



Performance Curves

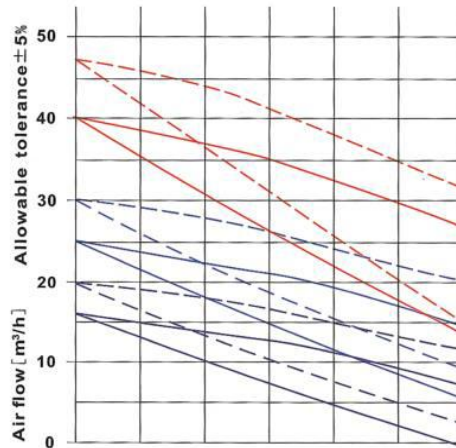
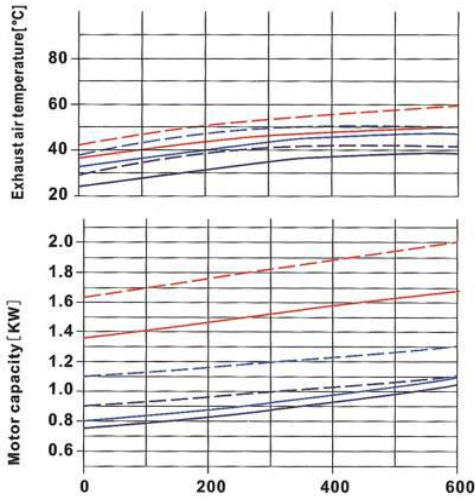

1 refers to atmospheric pressure
2 refers to intake pressure

Reference: 1000 mbar
Atmosphere: 20°C

Vacuum [bar]

ZYBW16K
ZYBW25K
ZYBW40K

50Hz
60Hz

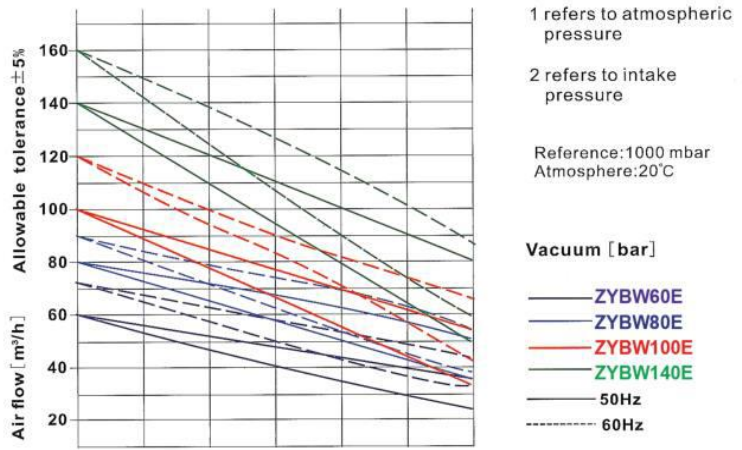
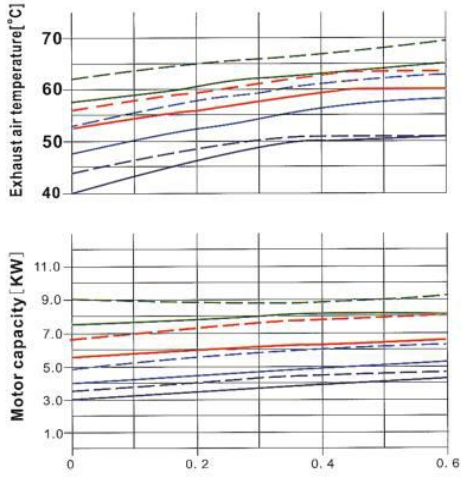

Dimension(mm)

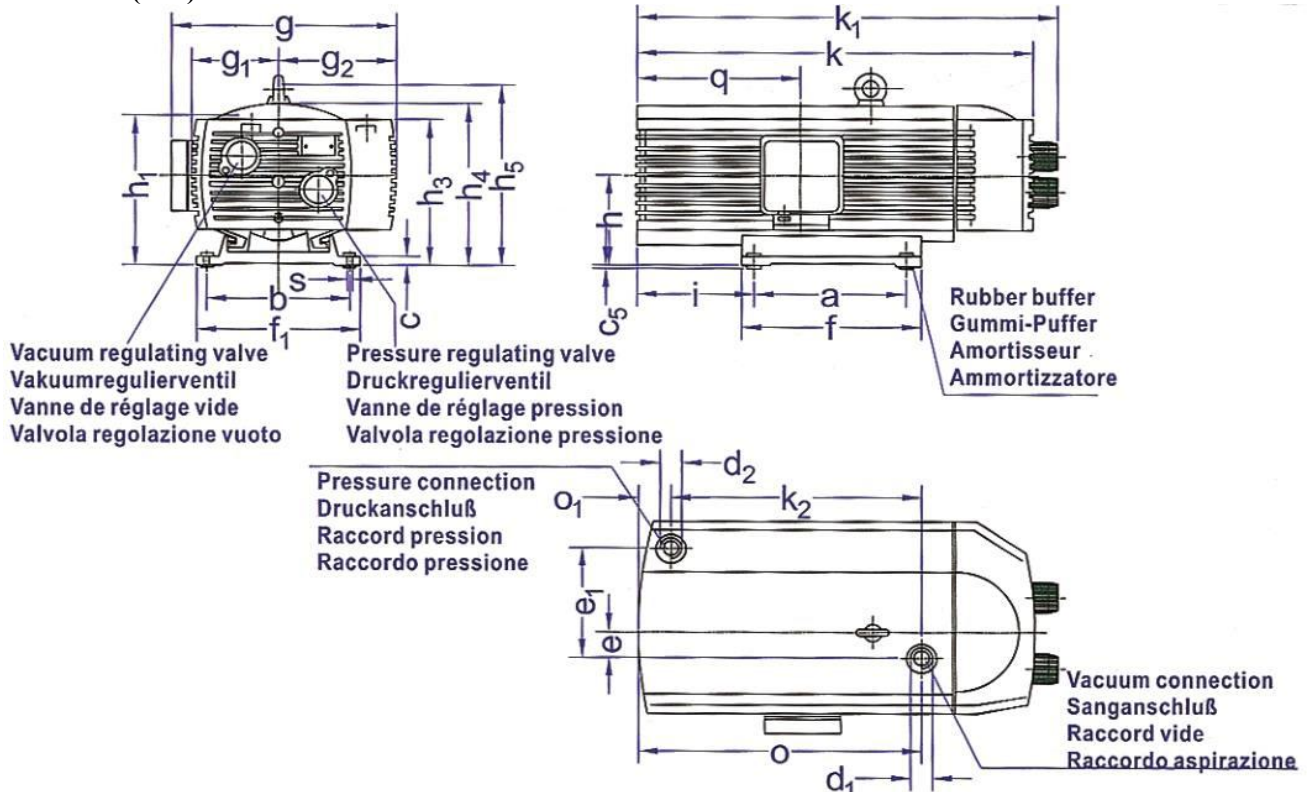

Type	a	b	c	c5	d1	d2	e	e1	f	f1	g	g1	g2	h	h1	h2
------	---	---	---	----	----	----	---	----	---	----	---	----	----	---	----	----

ZYBW16K	205	128	15	3	G1/2"	G1/2"	37.5	155	244	156	283	105.5	155.5	110	200	200
ZYBW25K	220	198	15	3	G3/4"	G3/4"	40	170	260	238	328	125	173	140	229	214
ZYBW40K	220	198	15	3	G3/4"	G3/4"	40	170	261	240	321	126	174	140.5	229	214

Type	h3	h4	h5	i	k	k1	k2	o	o1	q	s
ZYBW16K	205	210	225	110	465	511	296	331	34.8	182	7
ZYBW25K	227	250	290	130	505	545	281.5	336.3	54.8	178	7
ZYBW40K	223.5	249	295	177.5	586	617	362	414	55	214	7

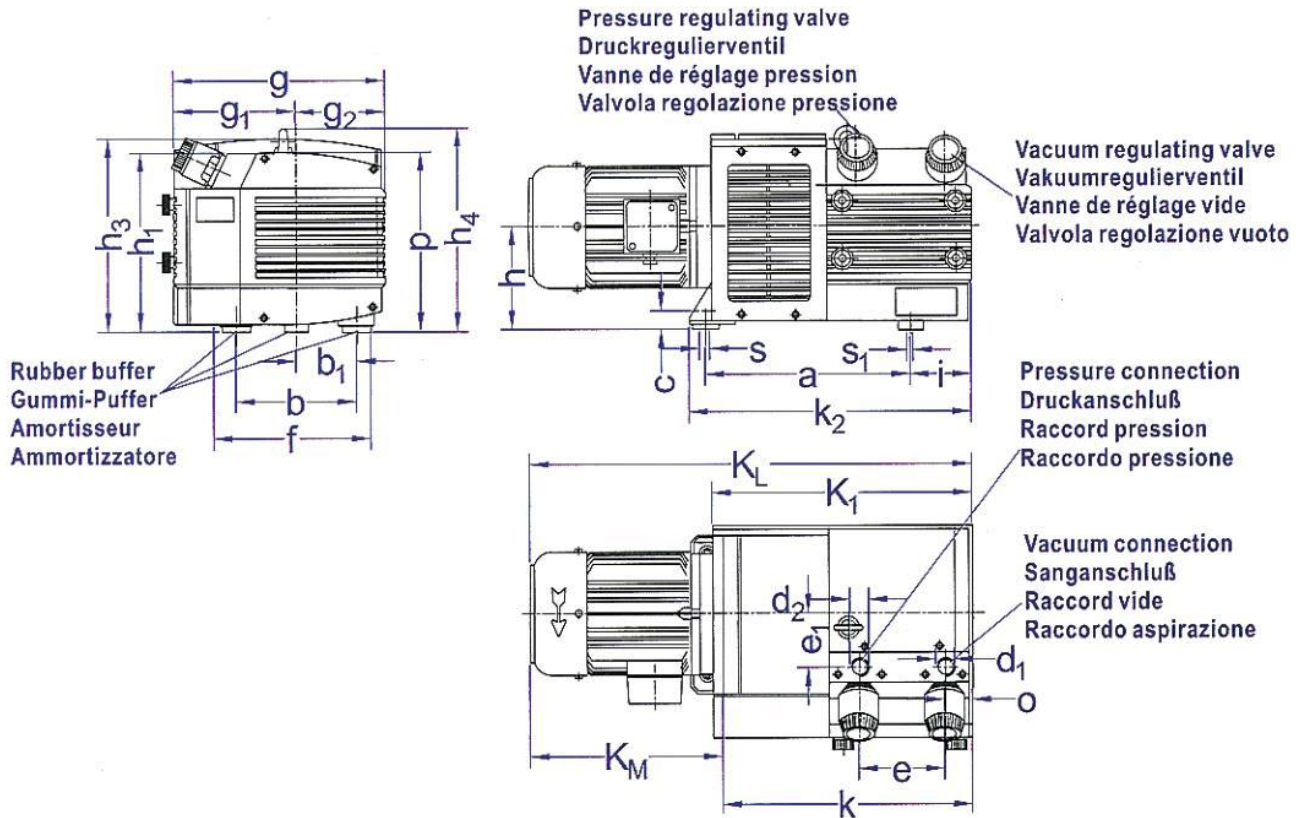

Type	a	b	b1	c	d1	d2	e	e1	f	g	g1	g2	h	h1	h3	h4
ZYBW60E	327	190	95	33	G1"	G1"	138	65	235	355	189	150	161	275	314	331
ZYBW80E	327	190	95	33	G1"	G1"	138	65	235	355	189	150	161	275	314	331
ZYBW100E	411.5	245	134	33	G1-1/2"	G1-1/2"	234	95	295	470	232.5	221.5	162	335	376	382
ZYBW140E	401.5	245	134	33	G1-1/2"	G1-1/2"	234	95	295	470	232.5	221.5	162	335	376	382

Type	i	k	k1	k2	km	ki	o	p	o	s1
ZYBW60E	93.5	401	414	451	<330	<728.5	49.5	289	12	M8
ZYBW80E	93.5	401	414	451	<330	<731	49.5	289	12	M8
ZYBW100E	146.5	527.5	543	570	<374	<895	24	336	12	M8
ZYBW140E	146.5	527.5	543	570	<398	<925.5	24	336	12	M8